



KARMA

MARTELLINA



Martellina minimal design | Minimal design handle
Bequille a poignee design minimaliste | Maneta de diseño minimal



Manico in alluminio pressofuso, rotore in zama, cassa in derlin, cover in alluminio, viti e perno in acciaio e bussola in zama.



Handle in die-cast aluminium, zamak rotor, derlin case, aluminium cover, steel screws and pin, zamak bush.



Manche en aluminium moulé sous pression, rotor en zamak, caisse en derlin, cover en aluminium, vis et pivot en acier, bague en zamak.



Mango en aluminio de fundición, rotor en zamac, caja en derlin, tapa en aluminio, tornillos y perno en acero, casquillo en zamac.



ART.	3091.30 3091.31 3091.32 3091.33 3091.34	3091.13
Imballo Package Conditionnement Embalaje	5 PZ	5 Cp
Finiture disponibili Available finishes Finitions disponibles Acabados disponibles	1 2 3 4	1 2 3 4

Art. 3091.3X

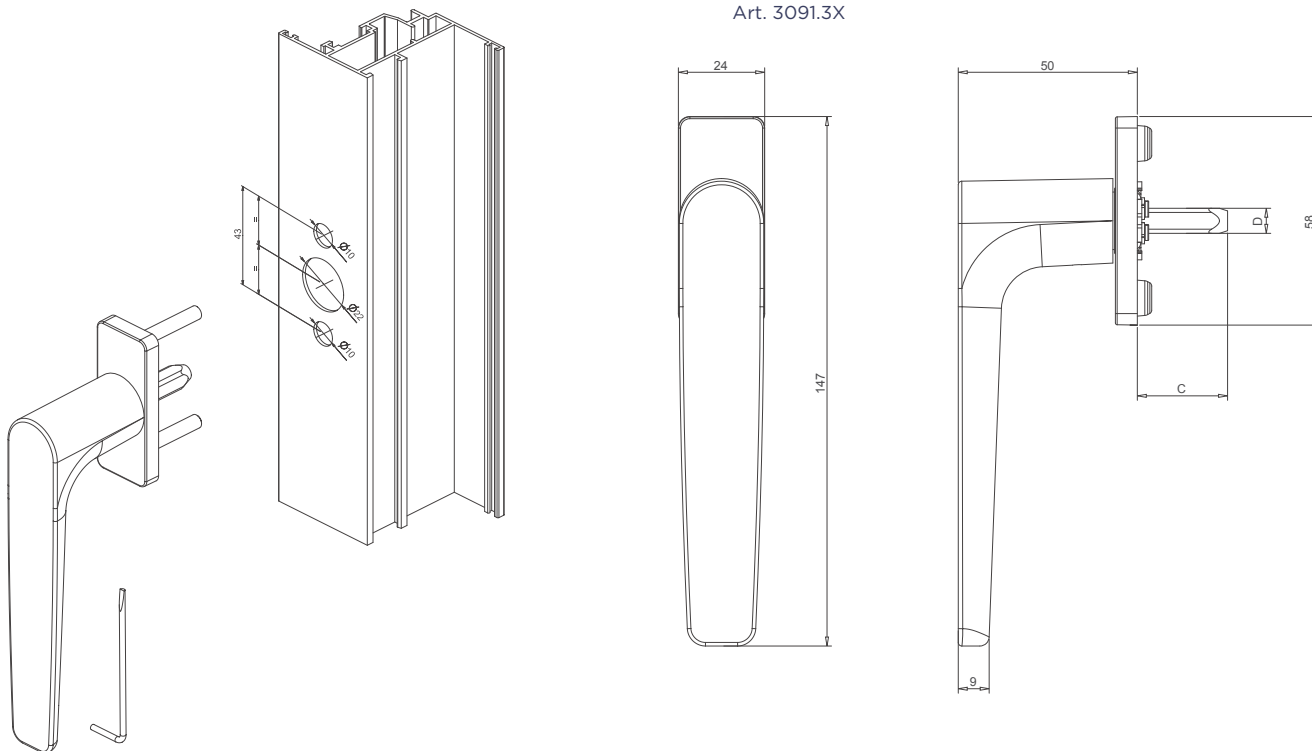

DESCRIZIONE DESCRIPTION	ART.	C	D
Martellina minimal design - Int. 43mm Minimal design handle - Int. 43mm	3091.30	8,5-27mm	7
Martellina minimal design - Int. 43mm Minimal design handle - Int. 43mm	3091.31	18,5-37mm	7
Martellina minimal design - Int. 43mm Minimal design handle - Int. 43mm	3091.32	23,5-42mm	7

DESCRIZIONE DESCRIPTION	ART.	C	D
Martellina minimal design - Int. 43mm Minimal design handle - Int. 43mm	3091.33	33,5-52mm	7
Martellina minimal design - Int. 43mm Minimal design handle - Int. 43mm	3091.34	53,5-72mm	7
Doppia martellina minimal design - Int. 43mm Minimal design double handle - Int. 43mm	3091.13	Max 65mm	7